

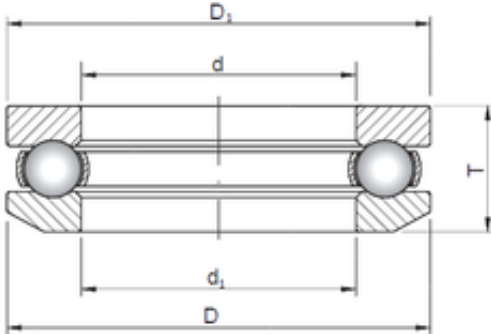

ISO 53309 thrust ball bearings



Bearing No. 53309

Bore Diameter	45 mm
Outer Diameter	85 mm
d	45 mm
d1	47 mm
D	85 mm
D1	85 mm
T	30,1 mm

53309 Bearing 2D drawings and 3D CAD models